

Strom Plumbing

BY
Sign of  the Crab

Ph: (916) 638-2722 / Fax: (916) 638-2725

Installation Information

Item #P0180

Warranted only if installed by a qualified licensed plumber.
Use Teflon paste or tape on all threaded connections.

1. Thread the shower head onto the shower arm or riser and hand tighten.
2. Turn on the water to check for leaks.
If leaks occur, carefully tighten the head using a wrench (wrap with duct tape to protect the finish of the product).

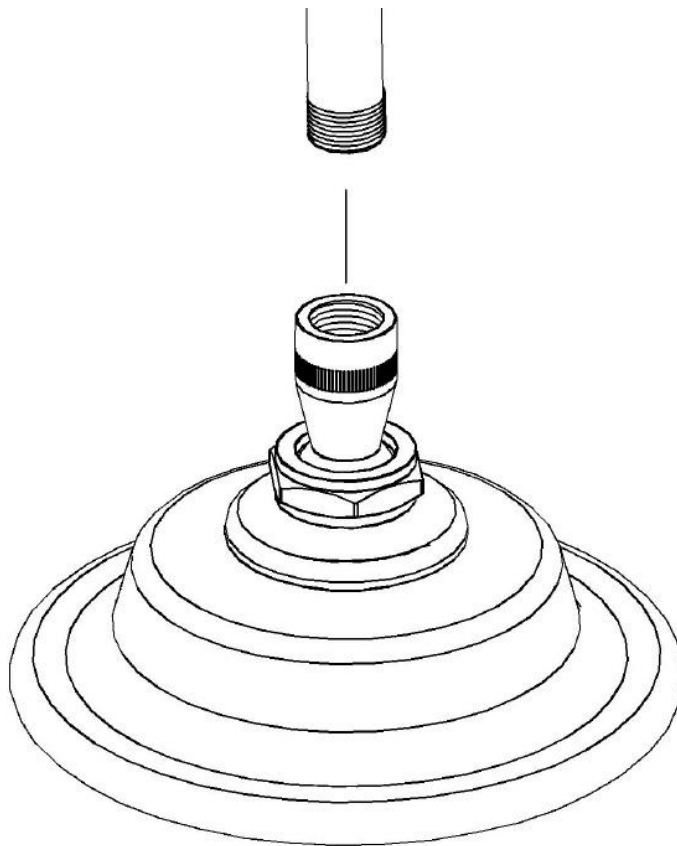

FAX 916-638-2725